



FOXY ADVANCED

PASSION OF MOVEMENT

www.panther.tv



The New Big Base

The Big Base was designed to ensure greater stability and security. By simply turning the base 90° you can choose between 62cm and 100cm track gauge.

Die Big Base wurde konstruiert um höhere Stabilität und Sicherheit zu gewährleisten. Sie können durch drehen der Basis um 90° zwischen 62cm und 100cm Spurbreite wählen.

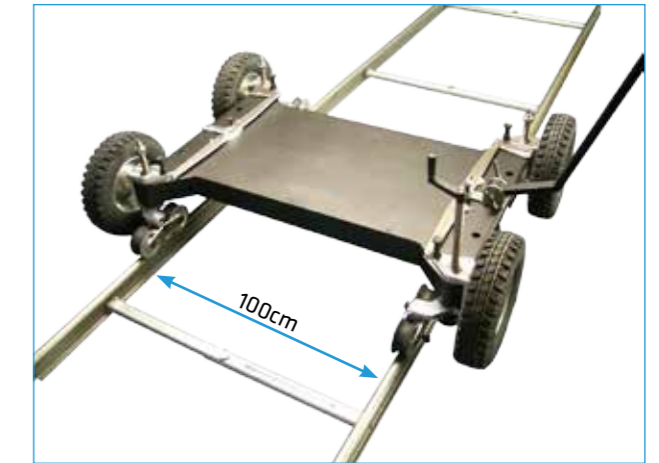
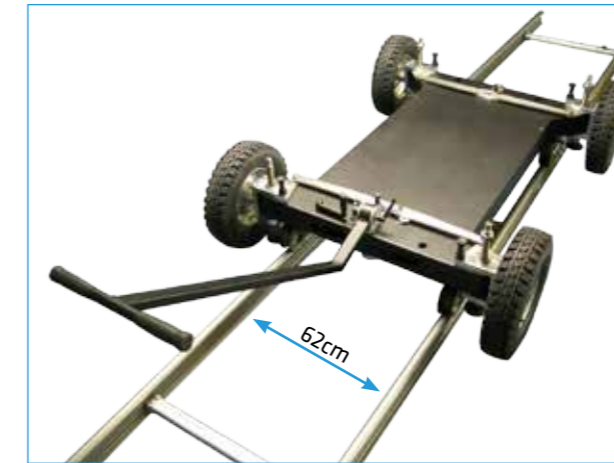

Footprint
Spindle: 78 x 116cm
2.5 x 3.8 ft.
Track: 62 x 102cm
2 x 3.3 ft.

Standfläche
Spindel: 78 x 116cm
Schiene: 62 x 102cm

Footprint
Spindle: 78 x 116cm
2.5 x 3.8 ft.
Track: 100 x 93cm
3.3 x 3 ft.

Standfläche
Spindel: 78 x 116cm
Schiene: 100 x 93cm

Width / Breite: 112cm (3.6 ft.) | Length / Länge: 156cm (5.1 ft.)

The Big Base offers 2 steering modes (front and 4-wheel).

Mit der Big Base können Sie zwischen 2 Lenkmodi wählen (vorne und 4-Rad).

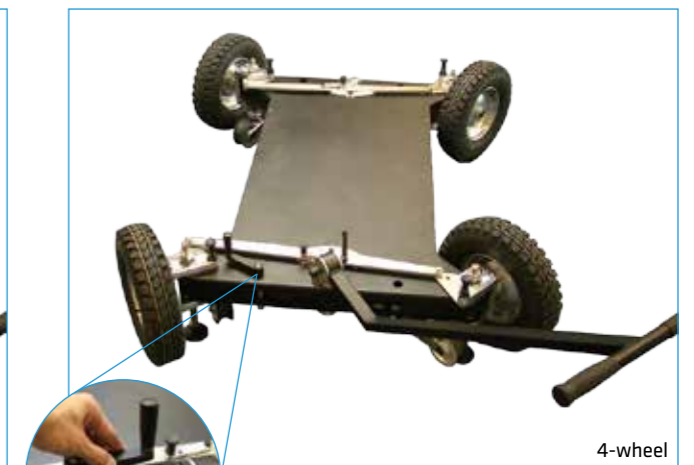

park position for crank handle



diameter 40cm / 1.3 ft.

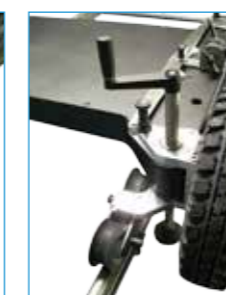

integrated spindle



brake



quick lock for easy wheel change

Simply Intelligent

At the present time, the demands of modern production are particularly high. There is much produced - with complex tasks. With high safety awareness and little budget. And even less time and personnel.

Panther took into consideration and found an intelligent solution to these problems. The Foxy Advanced, a unique and patented crane concept.

In der heutigen Zeit sind die Anforderungen einer modernen Produktion besonders hoch. Es wird viel produziert - mit komplexen Aufgaben. Mit hohem Sicherheitsbewußtsein und wenig Budget. Und noch weniger Zeit und Personal.

Panther hat sich Gedanken gemacht und für diese Probleme eine intelligente Lösung gefunden. Den Foxy Advanced, ein einzigartiges und patentiertes Krankonzept.

Compact Transport

Form follows function. The Foxy Advanced pyramid was designed in such a way that it can be used as the storage point for all crane parts. The patented construction facilitates easy transport and orderly storage of all elements of the Foxy Advanced Crane. All it takes now is one person to transport the crane to the location site.

Form follows function. Die Foxy Advanced Pyramide bietet eine wertvolle Hilfsfunktion: Die Aufnahme aller Einzelteile. Diese patentierte Konstruktion ermöglicht den einfachen Transport und die übersichtliche Lagerung aller Kranelemente. Jetzt kann eine Person den kompletten Kran auf einmal zur Location bringen.



It's lower. It's higher.
It's **ADVANCED!**



ADVANCED Upgrade

New features:

- Big Base
- bigger wheels on the base (40cm diameter)
- pyramid for 9 outriggers
- quicklock track wheels
- tool-free assembly
- 2-wheel and 4-wheel steering
- Double V-Bracing
- extended length up to 13.2m / 43.5 ft.
- higher payload up to 250kg / 550lbs
- additional safety (100cm track gauge)

Das ist neu:

- Big Base
- größere Räder an der Basis (40cm Durchmesser)
- Pyramide für 9 Ausleger
- Quicklock Schienenräder
- Werkzeugloser Aufbau
- 2-Rad und 4-Rad Lenkung
- Double V-Bracing
- erweiterte Länge bis zu 13,2m
- höhere Traglast bis zu 250kg
- zusätzliche Sicherheit (100cm Spurweite)



detachable platform
for special shots

Foxy Advanced - Platform Version

The platform version of the Foxy Advanced features 4 variants. From 2.8 m up to 7.3 m length there is no limit to your creativity.

Die Plattform Version des Foxy Advanced bietet Ihnen 4 Aufbau Varianten. Von 2,8m bis 7,3m Länge sind Ihrer Kreativität keine Grenzen gesetzt.

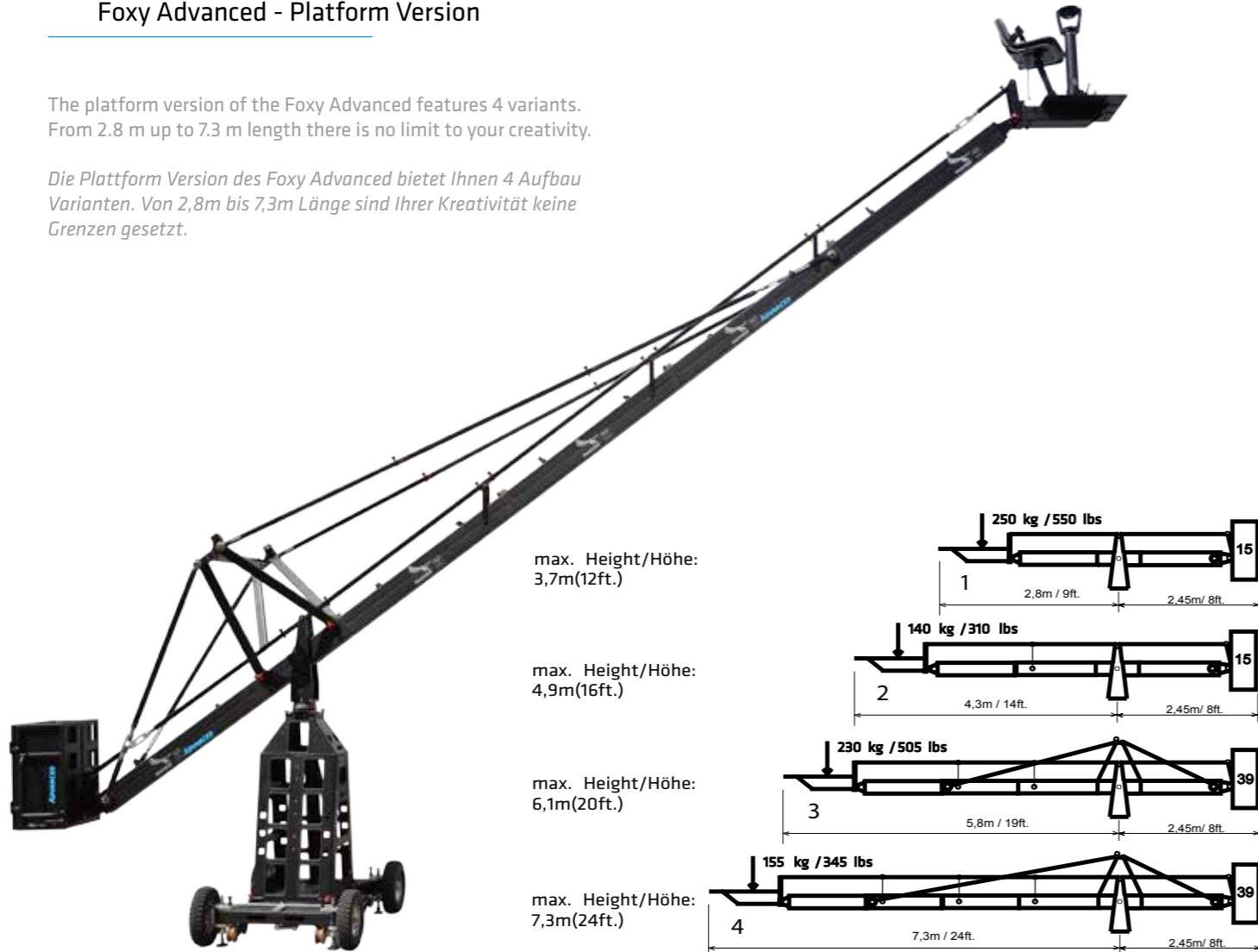

Foxy Advanced - Remote Version

The remote version offers 8 standard variants as well as many special variants. Adjust your Foxy Advanced to your needs. From 2.7 m up to 13.2 m length you will find something for every preference. And what doesn't fit is made to fit - for special lengths, versions and accessories don't hesitate to ask us.

In der Remote Version können Sie zwischen 8 Standard Varianten sowie vielen Sonder-Varianten auswählen. Passen Sie sich Ihren Foxy Advanced ganz nach Ihren Bedürfnissen an. Von 2,7m bis hin zu 13,2m Länge ist für jeden Bedarf etwas dabei. Und was nicht passt wird passend gemacht - für weitere Längen, Versionen und Zubehör fragen Sie einfach nach.

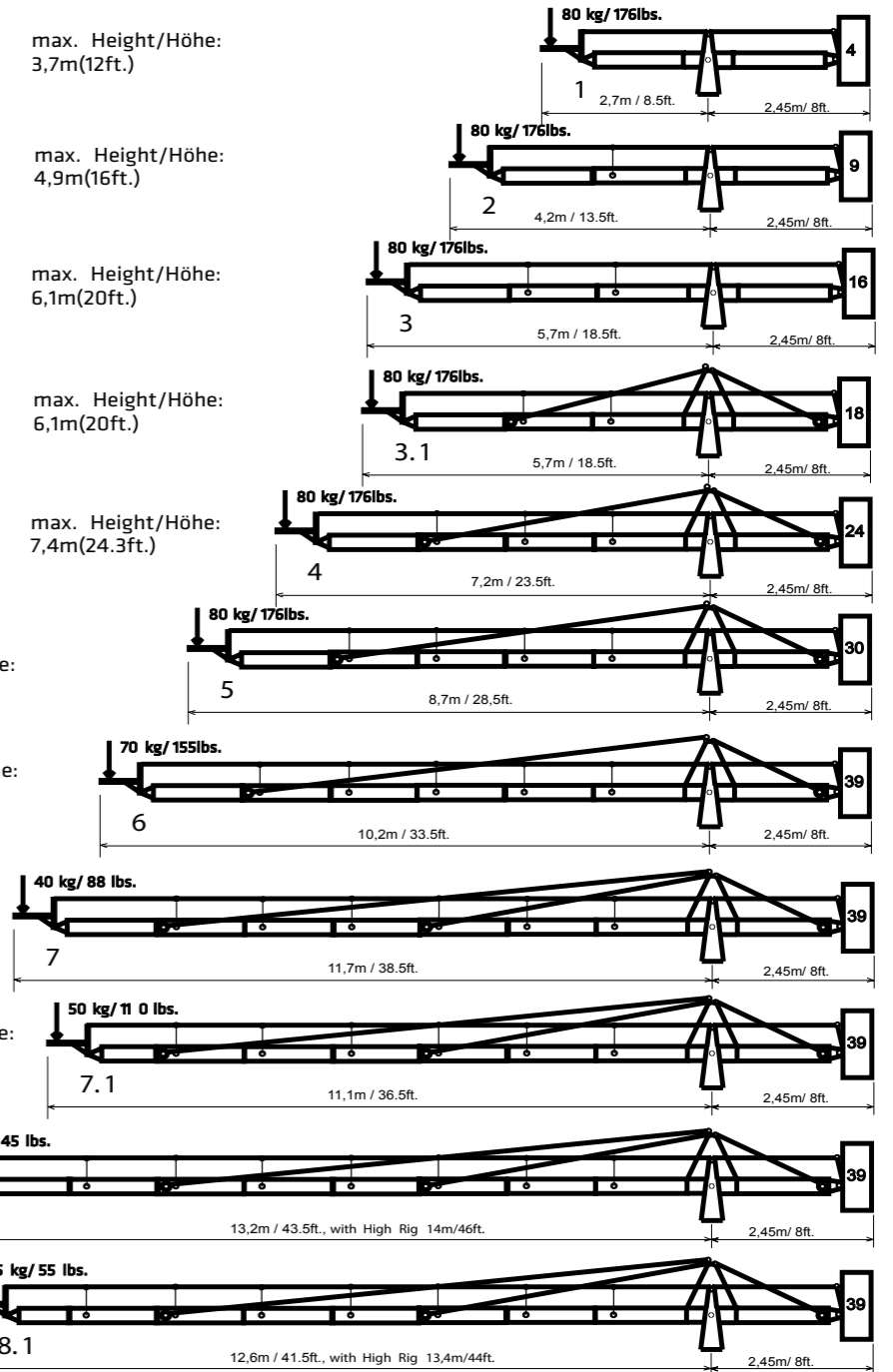
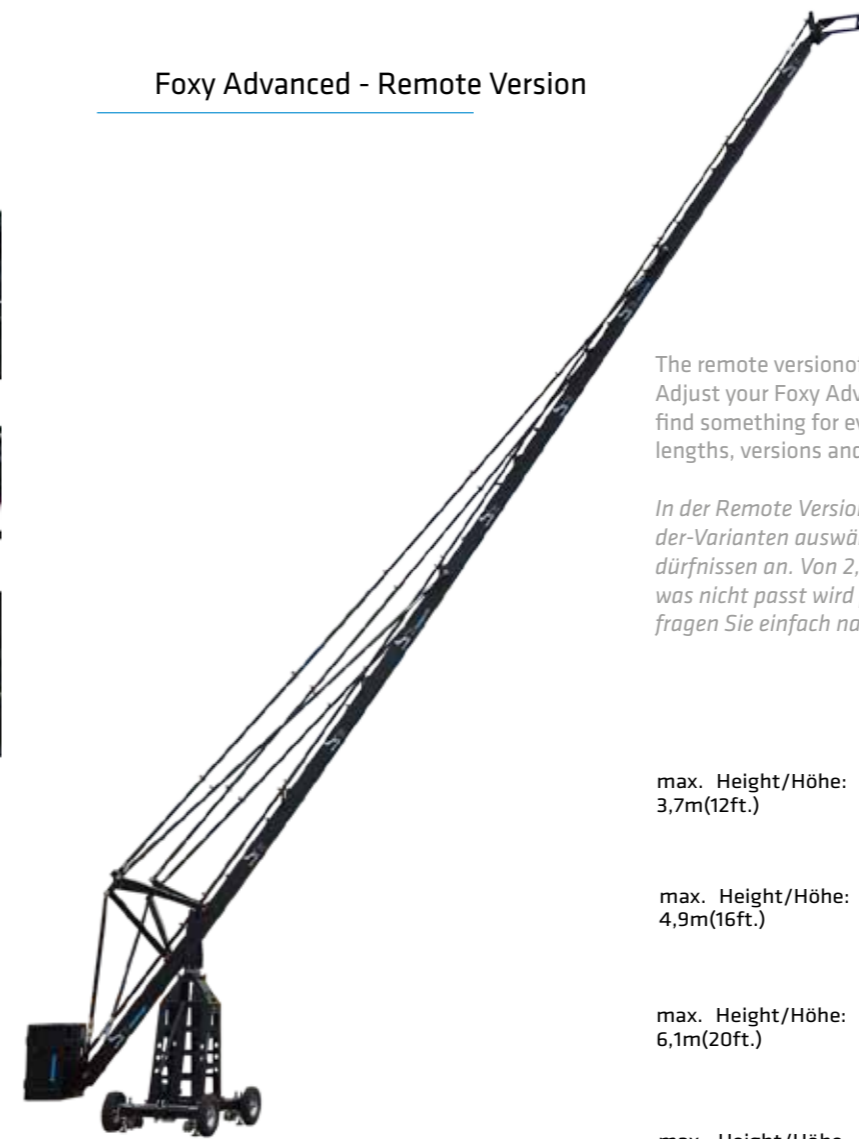

Special length, versions and accessories on request.

Weitere Längen, Versionen und Zubehör auf Anfrage.

Use It On **YOUR** Next Set



PANTHER GmbH | Raiffeisenallee 3 | 82041 Oberhaching-Munich | Germany
T +49.89.61 39 00 01 | F +49.89.61 31 00 0
contact@panther.tv | www.panther.tv